

## INTRODUCTION

Thank you for choosing an HK Instruments RHT-MOD Duct series relative humidity transmitter with Modbus interface. The RHT-MOD Duct series is intended for use in commercial environments in HVAC/R applications.

RHT-MOD Duct is a relative humidity transmitter with temperature output installed in air ventilation duct. Illuminated display ensures easy readability also from a distance. The RHT-MOD Duct has a screwless lid and an easily adjustable mounting flange that make the installation of the device easy.

## APPLICATIONS

RHT-MOD Duct series devices are commonly used to monitor and control:

- Relative humidity and temperature levels of incoming and return air in ventilation system

## SPECIFICATIONS

### Performance

**Measurement ranges:**

Temperature: 0...50 °C

Relative humidity: 0-100 %

**Accuracy:**

Temperature: &lt;0.5 °C

Relative humidity: ±2...3 % at 0...50 °C and 10-90 % rH

Total error band includes accuracy, hysteresis and temperature effect over 5...50 °C and 10-90% rH.

### Technical Specifications

**Media compatibility:**

Dry air or non-aggressive gases

**Measuring units:**

°C and % rH

**Measuring element:**

Temperature: NTC10K

Relative humidity: Thermoset polymer capacitive sensing element

**Environment:**

Operating temperature: 0...50 °C

Storage temperature: -20...70 °C

Humidity: 0 to 95 % rH, non condensing

### Physical

**Dimensions:**

Case: 119 x 100 x 44.7 mm

Probe: L=188 mm, d=12 mm

**Mounting:**

With flange, adjustable 0...188 mm

**Weight:**

150 g

**Materials:**

Case: ABS

Cover: PC

Probe: ABS

Mounting flange: LLPDP

**Protection standard:**

IP54

**Electrical connections:**

4 spring loaded terminals

**Power supply:**

(24 V and GND)

0.2-1.5 mm<sup>2</sup> (12-24 AWG)**Modbus RTU:**

A and B line

0.2-1.5 mm<sup>2</sup> (12-24 AWG)

## WARNING

- READ THESE INSTRUCTIONS CAREFULLY BEFORE ATTEMPTING TO INSTALL, OPERATE OR SERVICE THIS DEVICE.
- Failure to observe safety information and comply with instructions can result in PERSONAL INJURY, DEATH AND/OR PROPERTY DAMAGE.
- To avoid electrical shock or damage to equipment, disconnect power before installing or servicing and use only wiring with insulation rated for full device operating voltage.
- To avoid potential fire and/or explosion do not use in potentially flammable or explosive atmospheres.
- Retain these instructions for future reference.
- This product, when installed, will be part of an engineered system whose specifications and performance characteristics are not designed or controlled by HK Instruments. Review applications and national and local codes to assure that the installation will be functional and safe. Use only experienced and knowledgeable technicians to install this device.

### Electrical

Supply voltage: 24 VAC or VDC ±10 %

Current consumption: max 90 mA (at 24 V) + 10 mA for each voltage output

### Communication

Protocol: MODBUS over Serial Line

Transmission Mode: RTU

Interface: RS485

Byte format (11 bits) in RTU mode:

Coding System: 8-bit binary

Bits per Byte:

1 start bit

8 data bits, least significant bit sent first

1 bit for parity

1 stop bit

Baud rate: selectable in configuration

Modbus address: 1-247 addresses selectable in configuration menu

### Conformance

Meets requirements for CE marking:

EMC Directive: 2014/30/EU

RoHS Directive: 2011/65/EU

WEEE Directive: 2012/19/EU

COMPANY WITH  
MANAGEMENT SYSTEM  
CERTIFIED BY DNV GL  
= ISO 9001 = ISO 14001 =



## SCHEMATICS

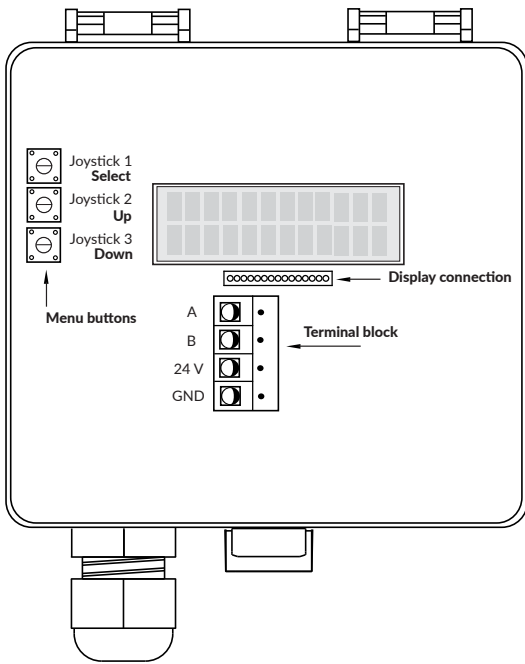

## DIMENSIONAL DRAWINGS

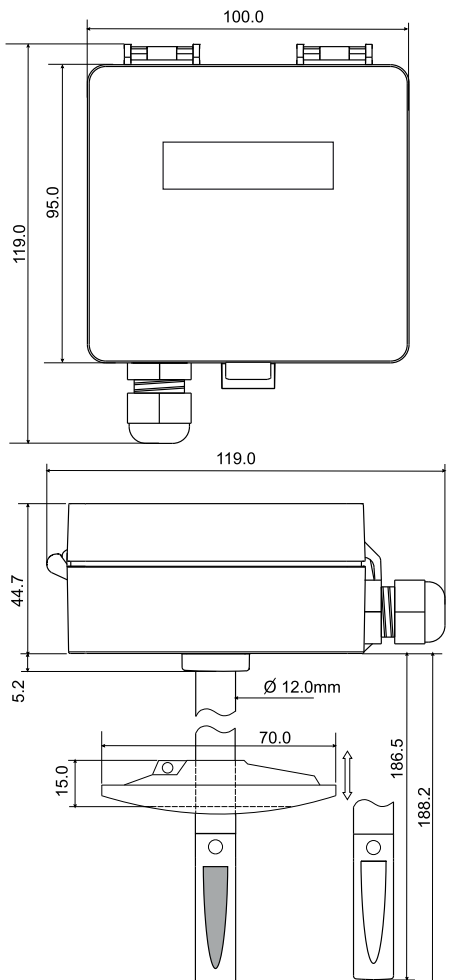

## INSTALLATION

- 1) Mount the device in the desired location (see step 1).
- 2) Route the cables and connect the wires (see step 2).
- 3) The device is now ready for configuration.

**⚠ WARNING!** Apply power only after the device is properly wired.

### STEP 1: MOUNTING THE DEVICE

- 1) Select the mounting location (on a duct).
- 2) Use the mounting flange of the device as a template and mark the screw holes.
- 3) Mount the flange on the duct with screws (not included). (Figure 1a)
- 4) Adjust the probe to the desired depth. Ensure that the end of the probe reaches the middle of the duct. (Figure 1b)
- 5) Tighten the screw on the flange to hold the probe in position.

**Figure 1a - Mounting a flange**

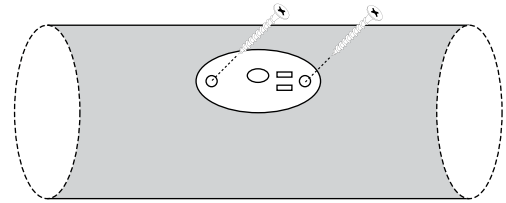

**Figure 1b - Mounting the probe in a flange**

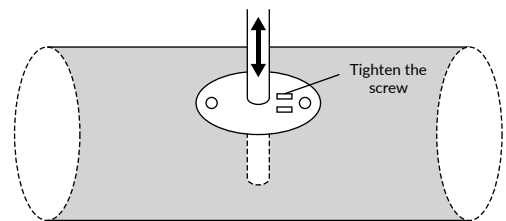

**Figure 1c - Mounting orientation**

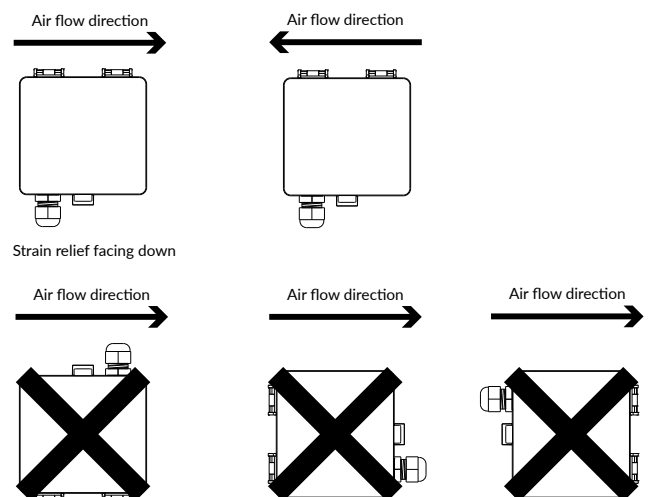

## STEP 2: WIRING DIAGRAMS

For CE compliance a properly grounded shielding cable is required.

- 1) Unscrew the strain relief and route the cable(s).
- 2) Connect the wires as shown in figure 2a.
- 3) Tighten the strain relief.

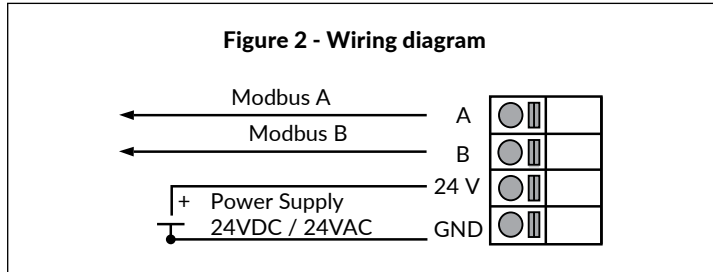

## STEP 3: CONFIGURATION

- 1) Activate the device Menu by pushing the the select button for 2 seconds.

- 2) Select the address for Modbus: 1...247.

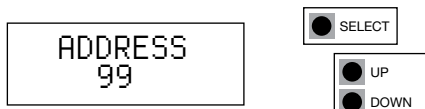

- 3) Select the baud rate: 9600/19200/38400.



- 4) Select the parity bit: None/Even/Odd.

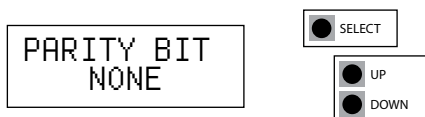

- 5) Select humidity offset: +10 % rH, Offset feature enables field calibration. This is necessary in demanding applications requiring annual calibration.



- 6) Select temperature offset: +5 °C or +9 °F



- 7) Push the select button to exit menu.



## STEP 4: MODBUS REGISTERS

Function 04 - Read input register

Register	Parameter description	Data Type	Value	Range
3x0001	Program version	16 bit	0...1000	0.0...99.00
3x0003	rH reading	16 bit	0...1000	0.0...100.0 %
3x0004	Temperature reading	16 bit	0...500	0.0...50.0 °C

## RECYCLING/DISPOSAL

The parts left over from installation should be recycled according to your local instructions. Decommissioned devices should be taken to a recycling site that specializes in electronic waste.



## WARRANTY POLICY

The seller is obligated to provide a warranty of five years for the delivered goods regarding material and manufacturing. The warranty period is considered to start on the delivery date of the product. If a defect in raw materials or a production flaw is found, the seller is obligated, when the product is sent to the seller without delay or before expiration of the warranty, to amend the mistake at his/her discretion either by repairing the defective product or by delivering free of charge to the buyer a new flawless product and sending it to the buyer. Delivery costs for the repair under warranty will be paid by the buyer and the return costs by the seller. The warranty does not comprise damages caused by accident, lightning, flood or other natural phenomenon, normal wear and tear, improper or careless handling, abnormal use, overloading, improper storage, incorrect care or reconstruction, or changes and installation work not done by the seller or his/her authorized representative. The selection of materials for devices prone to corrosion is the buyer's responsibility, unless otherwise is legally agreed upon. Should the manufacturer alter the structure of the device, the seller is not obligated to make comparable changes to devices already purchased. Appealing for warranty requires that the buyer has correctly fulfilled his/her duties arisen from the delivery and stated in the contract. The seller will give a new warranty for goods that have been replaced or repaired within the warranty, however only to the expiration of the original product's warranty time. The warranty includes the repair of a defective part or device, or if needed, a new part or device, but not installation or exchange costs. Under no circumstance is the seller liable for damages compensation for indirect damage.